



S1A1038804

1 Preliminary information

Information below is designed to use for simple applications with 2-wire control mode and freewheel stop.

If you need more information, or for other applications, see the User manual (BBV51330) on www.schneider-electric.com. For a hard copy, contact your local sales Office or Schneider Electric representative.

Note:
DO NOT USE this guide for Altistart 22 connected inside the delta of the motor (it means Altistart 22 connected to the motor with delta connections in series with each motor windings). In this case, see User manual on www.schneider-electric.com.
Read and understand these instructions before performing any procedure with this soft starter.

DANGER

HAZARD OF ELECTRIC SHOCK, EXPLOSION AND ARC FLASH

Read and understand this manual before installing or operating the Altistart 22 starter. Installation, adjustment, repair, and maintenance must be performed by qualified personnel.

- The user is responsible for compliance with all international and national electrical code requirements with respect to grounding of all equipment.
- Many parts of this soft starter, including the printed circuit boards, operate at the line voltage. DO NOT TOUCH. Use only electrically insulated tools.
- DO NOT touch unshielded components or terminal strip screw connections with voltage present.
- Before servicing the starter:
 - Disconnect all power, including external control power that will be present.
 - Place a "DO NOT TURN ON" label on all power disconnects.
 - Lock all power disconnects in the open position.
- Before applying power section close the enclosure.

Failure to follow these instructions will result in death or serious injury.

Electrical equipment should be installed, operated, serviced and maintained only by qualified personnel. No responsibility is assumed by Schneider Electric for any consequences out of the use of this material.

2 Check the delivery of the soft starter

Remove Altistart 22 from the packaging and check that it has not been damaged.

WARNING

DAMAGED SOFT STARTER EQUIPMENT

Do not operate or install any soft starter or soft starter accessory that appears damaged.

Failure to follow these instructions can result in death, serious injury, or equipment damage.

Ensure that the soft starter reference on the nameplate is similar to the purchase order delivery note.

Write the soft starter model Reference: **ATS22** _____
and Serial Number: _____



3 Check the line voltage compatibility

Check that the line voltage is compatible with the supply range of the soft starter.

Line voltage _____ Volts Soft starter voltage range _____ Volts

Control voltage _____ Volts Soft starter control voltage range _____ Volts

4 Mount the soft starter vertically

For a surrounding air temperature up to 40 °C (104°F).

DANGER

HAZARD OF ELECTRIC SHOCK, EXPLOSION AND ARC FLASH

ATS22 soft starters are open devices and must be mounted in a suitable enclosure.

Failure to follow these instructions will result in death or serious injury.

For other thermal conditions, see user manual (BBV51330) on www.schneider-electric.com.

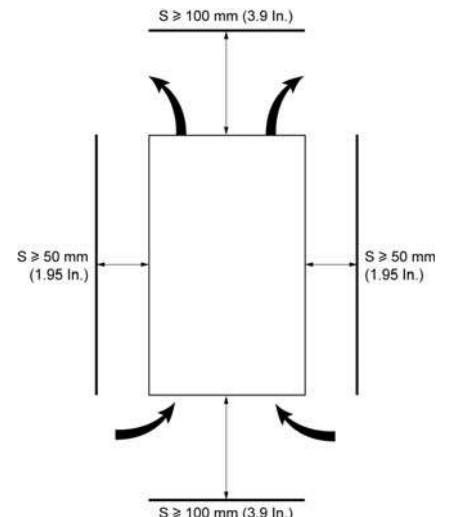

5 Connect the soft starter

For ATS22●●●Q or ATS22●●●S6 2-wire control, freewheel stop

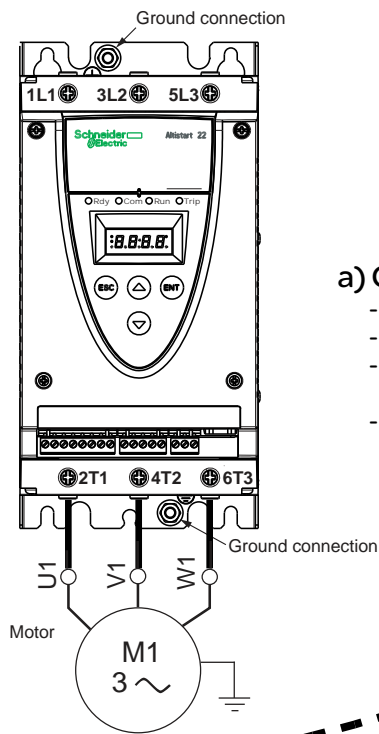

a) Connect Power:

- Wire the soft starter to the ground.
- Wire the soft starter to the line supply: 1/L1 - 3/L2 - 5/L3.
- Check that the motor voltage is compatible with the soft starter voltage.
- Wire the soft starter to the motor.

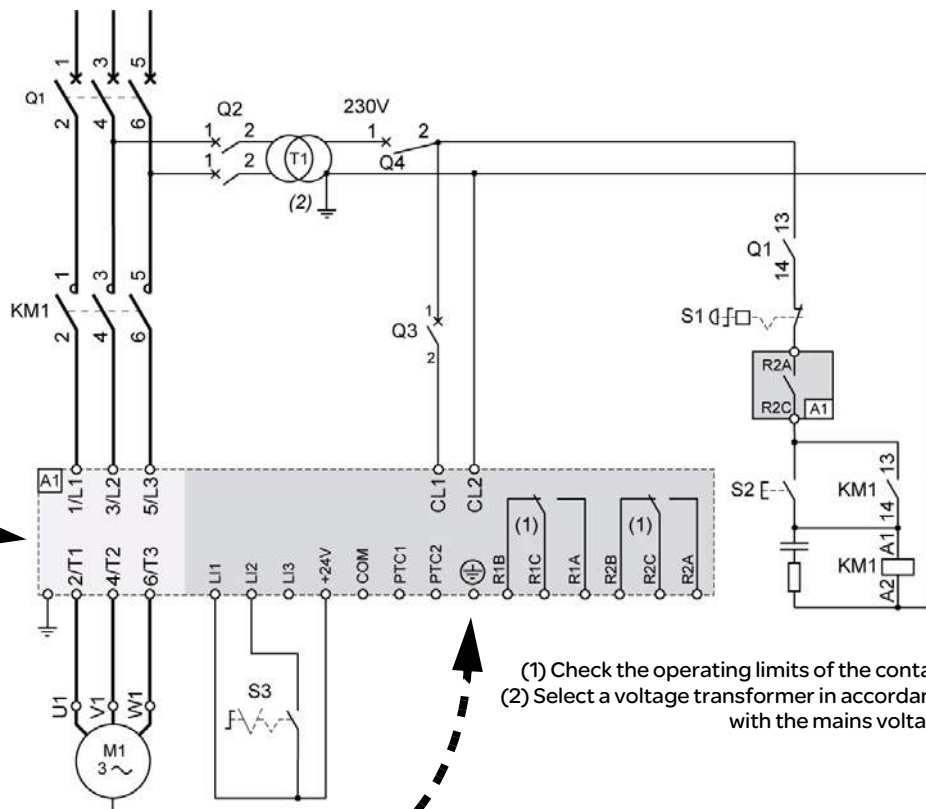

- (1) Check the operating limits of the contact.
- (2) Select a voltage transformer in accordance with the mains voltage.

b) Connect Control:

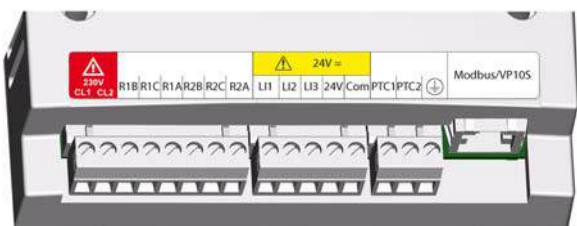

- Check that the control supply is **230V** for CL1 and CL2.
- Remove the red sticker which covers the CL1-CL2 terminals.
- Wire control supply: CL1 and CL2.
- Wire logical inputs: L1 and L2.
- Wire the relay: R2A and R2C.

Note: For additional information in order to size the protective and control devices, refer to the catalog or the user manual available on www.schneider-electric.com

6 Connect the soft starter

For ATS22●●●S6U

2-wire control, freewheel stop

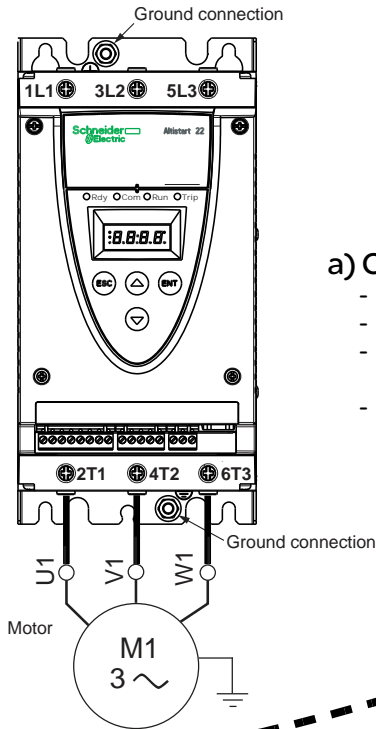

a) Connect Power:

- Wire the soft starter to the ground.
- Wire the soft starter to the line supply: 1/L1 - 3/L2 - 5/L3.
- Check that the motor voltage is compatible with the soft starter voltage.
- Wire the soft starter to the motor.

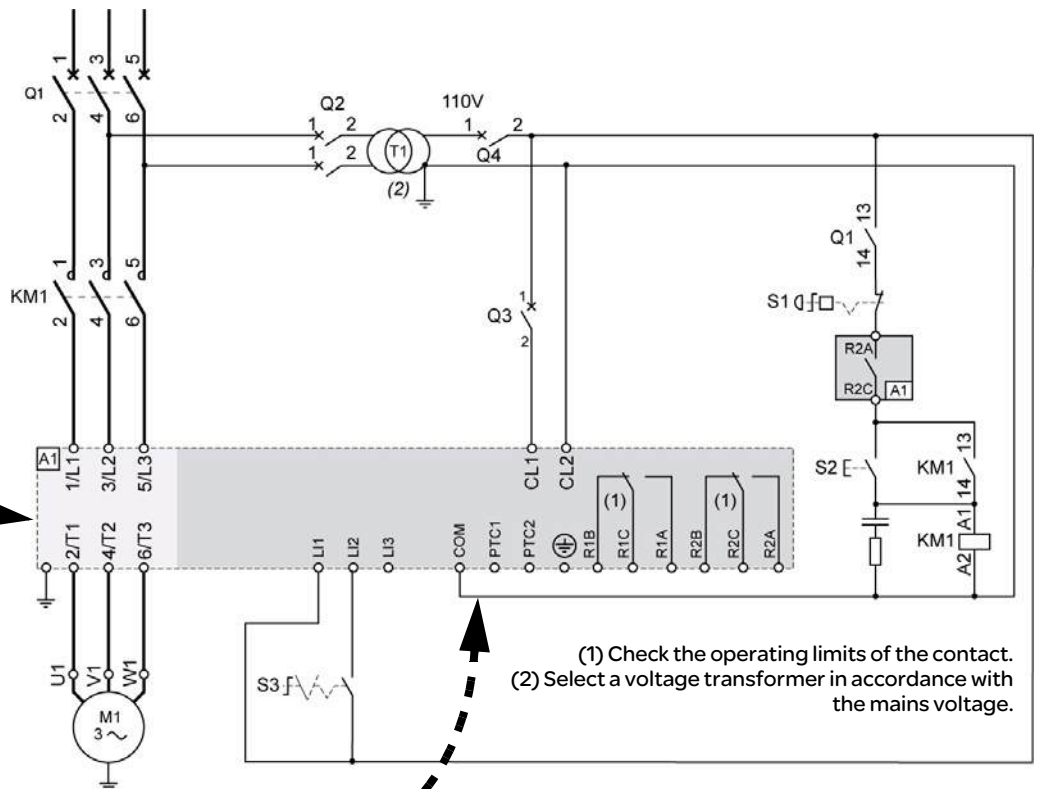

b) Connect Control:

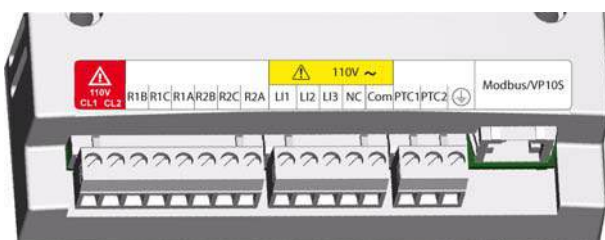

- Check that the control supply is **110V** for CL1 and CL2.
- Remove the red sticker which covers the CL1-CL2 terminals.
- Wire control supply: CL1 and CL2.
- Wire logical inputs: L1 and L2.
- Wire the relay: R2A and R2C.

Note: For additional information in order to size the protective and control devices, refer to the catalog or the user manual available on www.schneider-electric.com

7 Power on the control

- Check that S3 is open.
- Switch on: Q1, Q2, Q3 and Q4.
- The soft starter displays *rdy*.



8 Adjust U_{ln} line voltage

- Push scroll down button ▼ to reach *conf* menu.
- Push ENT button.
- Push scroll down button ▼ to reach U_{ln} parameter.
- Set U_{ln} to the main line voltage ac value, using scroll Up/down. ▲ ▼
- Push ENT button to validate the U_{ln} value.

9 Adjust I_n motor rated current

- In *conf* menu
- Push scroll down button ▼ to reach I_n parameter.
- See Nominal Motor Current on Motor Nameplate (Motor Full Load Amps) in STAR connection, note the “Amps” value.
- Set I_n to this value using scroll Up/down.
- Push ENT button to validate the I_n value.

10 Apply power to the Altistart 22 and start the motor

- Close the enclosure.
- Push S2 button.
- The soft starter displays *rdy*.
- Close S3, the motor starts.

Factory settings

The Altistart 22 is factory configured for most standard applications. If the factory configuration is not suitable for your application, refer to User manual (BBV51330) on www.schneider-electric.com. Here is the list of writable parameters in an “easy start up” mode.

Menu	Code	Description	Factory setting	Customer setting
<i>conf</i> Configuration	<i>ICL</i>	Soft starter rated current	According to the soft starter rating	
	<i>dLkA</i>	Connection type (Line or delta)	<i>LInE</i>	
	U_{ln}	Line voltage	ATS22●●●Q range: <i>400</i> Vac ATS22●●●S6-S6U ranges: <i>480</i> Vac	
	I_n	Motor rated current	According to the soft starter rating	
	<i>cod</i>	Setting lock	<i>nLoC</i> (Not locked)	
	<i>LAC</i>	Advanced mode	<i>oFF</i>	
<i>SEt</i> Adjustments	<i>t90</i>	Initial voltage	<i>30</i> % of input voltage	
	<i>ILt</i>	Current limit	<i>350</i> % of I_n	
	<i>tLS</i>	Max start time	<i>15</i> s	
	<i>ACC</i>	Acceleration time	<i>10</i> s	
	<i>DEC</i>	Deceleration time	<i>FrEE</i> (Freewheel)	
	<i>EdC</i>	Final torque	<i>0</i>	
	<i>tHP</i>	Motor thermal protection	<i>10</i> (IEC class 10)	

rdy: soft starter ready, when power and control voltage are present and the motor is not operating.

rrdy: when power is not supplied and control voltage is supplied or when power and control voltage are present with LI1 not connected and LI2 present (run command).